

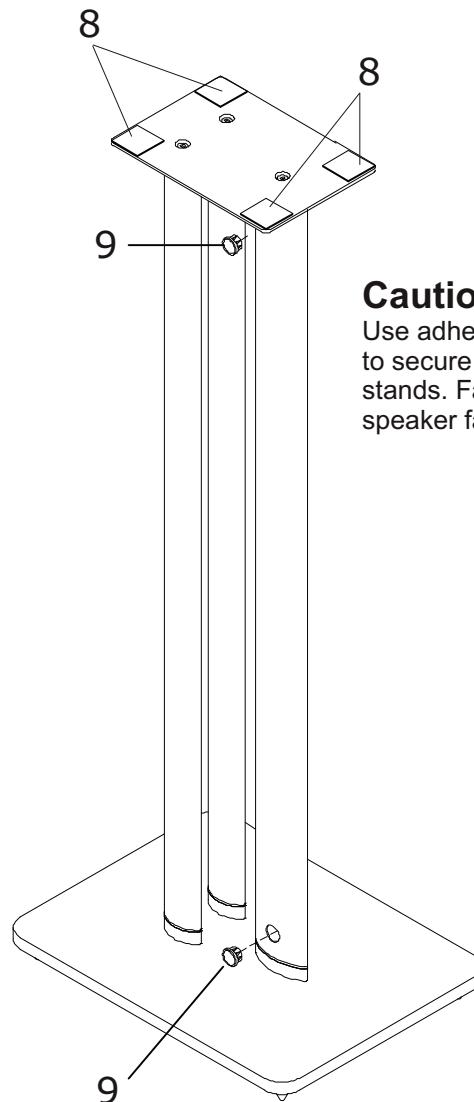

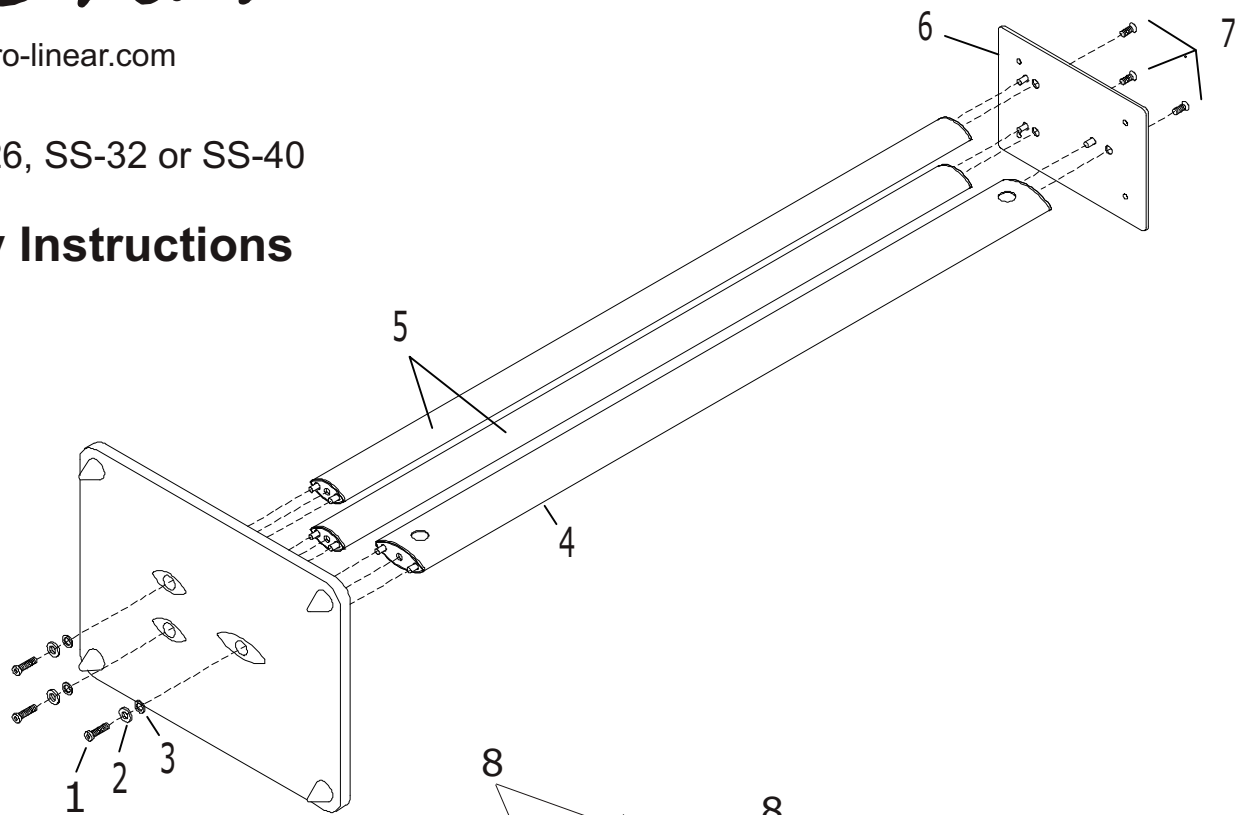







Pro-Linear

www.pro-linear.com

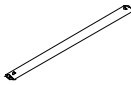
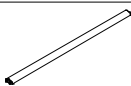
SS-BT + SS-26, SS-32 or SS-40

Assembly Instructions



①		6 PCS
②		6 PCS
③		6 PCS
④		2 PCS
⑤		4 PCS
⑥		2 PCS
⑦		6 PCS
⑧		8 PCS
⑨		4 PCS
⑩		1 PC

Caution:

Use adhesive putty (not included) to secure your speakers to the speaker stands. Failure to do so may result in the speaker falling off the stand.